

TREES

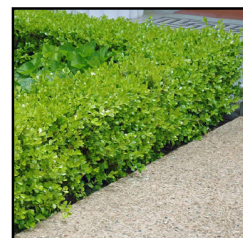

Acj **Acer palmatum 'Beni-kawa'**
Coral Bark Maple



Bus **Buxus sempervirens**
Dwarf Boxwood



Aw **Azalea gumpo white**
White gumpo azalea



Rmw **Rosa meidiland 'White'**
Meidiland White Rose



Ris **Ribes sanguineum**
Red Flowering Currant



St **Styrax japonica**
Japanese Snowbell Tree



Ec **Erica carnea 'Springwood White'**
Winter flowering heather



Rmy **Rosa meidiland 'Yellow'**
Meidiland Yellow Rose



Hs **Hosta sieboldii**
Hosta - variety of selections



Phl **Philadelphus lewisii**
Mock Orange



Ma **Malus floribunda**
Flowering Crabapple



Ep **Echinacea purpurea**
Purple Coneflower



Fg **Festuca gautieri**
Bearskin fescue



Ga **Gaultheria shallon**
Sallal



 **Polystichum munitum**
Western Sword Fern



PrS **Prunus serrulata 'Shirotae'**
Mt. Fuji Cherry



Caa **Calamagrostis acutiflora 'Karl Foerster'**
Feather Reed Grass



Sr **Sarcococca ruscifolia**
Fragrant sweet box

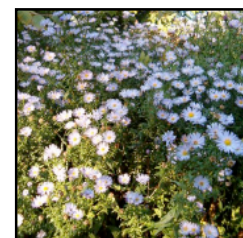

An **Aster novi-belgii**
Michaelmas Daisy



Cei **Ceanothus impressus 'Victoria'**
California Lilac



Vap **Vaccinium parvifolium**
Deciduous huckleberry



Cht **Choisya ternata**
Mexican orange



Lp **Lonicera pileata**
Privet Honeysuckle

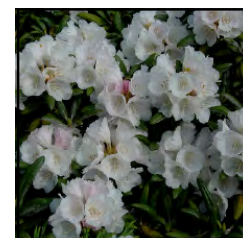

Rhs **Rhododendron 'Snow Lady'**
Snow Lady's Rhododendron

SHRUBS

Plant List for Plazas and Internal Gardens

Sym.	Latin Name	Common Name	Size	Cdn	
Trees					
Acpg	Acer palmatum 'sango-kaku'	Coral Bark Maple	1.5 m ht.	#10 pot	
Prs	Prunus serrulata 'Kwanzan'	Kwanzan Japanese Flowering Cherry	6 cm. cal.	B&B	
Prs	Prunus serrulata 'Mt. Fuji'	Mt. Fuji Japanese Flowering Cherry	7 cm. cal.	B&B	
Styj	Styrax japonica	Japanese Snowbell Tree	2.5 m. ht.	B&B	
Shrubs					
Aw	Azalea 'Gumpo White'	Gumpo White Azalea	0.3m ht.	#3 pot	
Cev	Ceanothus velutinus	Snowbush ceanothus	1.0m ht.	#3 pot	
Cht	Choisya ternata	Mexican Orange	0.5m ht.	#3 pot	
Ec	Erica carnea 'springwood white'	Springwood White Flowering Heather	0.3m ht.	#3 pot	
Hs	Hosta sieboldiana	Hosta	0.2m ht.	#1 pot	
Lp	Lonicera pileata	Box-leaf Honeysuckle	0.3m ht.	#3 pot	
Phl	Philadelphus lewisii	Mock Orange	1.0m ht.	#3 pot	
	Polystichum munitum	Western Sword Fern		#1 pot	
Rs	Ribes sanguineum	Red Flowering Current	1.5m ht.	#5 pot	
Rmy	Rosa meidiland Yellow	Meidiland Rose Yellow	0.3m ht.	#3 pot	
Vap	Vaccinium parvifolium	Red Huckleberry	0.6m. ht.	#3 pot	
Groundcovers and Perennials					
An	Aster novi-belgii	New York Aster		#1 pot	
Ep	Echinacea purpurea	Purple Coneflower	0.3m ht.	#3 pot	
Fo	Festuca ovina "Glaucia"	Elijah Blue Fescue		#1 pot	
Gs	Gaultheria shallon	Salal		10 cm pot	
La	Lavandula angustifolia 'Nana'	Dwarf Lavender	0.3m ht.	#3 pot	
Ps	Phlox subulata "Snowflake"	Creeping Phlox		10 cm pot	
Rh	Rudbeckia hirta 'Goldstrum'	Black Eyed Susan	0.3m ht.	#3 pot	

DATE	ISSUED
2019-06-07	Issued for DRC
2021-07-23	Revised and Reissued for Rezoning

REV.	DATE	DESCRIPTION
1.	21/07/23	GENERAL

AMBLESIDE INFILL
ESQUIMALT AVENUE,
WEST VANCOUVER
WALL FINANCIAL CORPORATION

V Vaughan
Landscape Planning
and Design
1406 Clyde Ave.,
West Vancouver, B.C.
Canada V7T 1G1
PH:922-1885
FAX:922-5485
office@vaughanplanning.com

DESIGNED	MCV
SCALE	
DATE	July 14, 2016

TITLE
PLANT LIST
PLAZAS AND GARDENS

DRAWING NO.	REV
L7	1

THIS REVISION SUPERCEDES DRAWINGS BEARING PREVIOUS REVISION NUMBER

TREES



St *Styrax japonica*
Japanese Snowbell Tree



La *Lavandula angustifolia* 'Nana'
Lavender Fern



Fg *Festuca gautieri*
Bearskin fescue

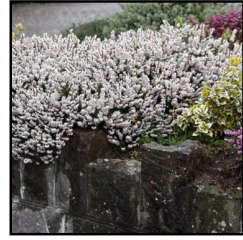

Ec *Erica carnea* 'Springwood White'
Winter flowering heather



Rmy *Rosa meidiland* 'Yellow'
Meidiland Yellow Rose



Mgst *Magnolia stellata*
Star Magnolia

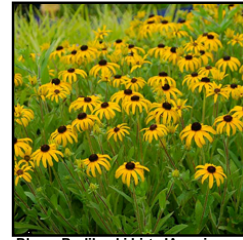

Rh *Rudbeckia hirta* 'American Gold Rush'
Black Eyed Susan



Lp *Lonicera pileata*
Privet Honeysuckle



Aw *Azalea gumpo white*
White gumpo azalea



Bus *Buxus sempervirens*
Dwarf Boxwood

SHRUBS

Plant List Street Side of Building

Symbol	Latin name	Common Name	Size	Cdn
Trees				
Most	<i>Magnolia Stellata</i>	Star Magnolia	2.5 m. ht.	#5 pot
Styj	<i>Styrax japonica</i>	Japanese Snowbell Tree	2.5 m. ht.	B&B
Shrubs				
Aw	<i>Azalea 'Gumpo White'</i>	Gumpo White Azalea	0.3m ht.	#3 pot
Bus	<i>Buxus sempervirens 'Winter Gem'</i>	Dwarf Boxwood 'Winter Gem'	0.3m ht.	#3 pot
Ec	<i>Erica carnea "Bell's Extra Special"</i>	Winter Flowering Heather "Bell's Extra Special"	0.3m ht.	#3 pot
Lp	<i>Lonicera pileata</i>	Honeysuckle	0.3m ht.	#3 pot
Rmw	<i>Rosa meidiland "White"</i>	Meidiland Rose White	0.3m ht.	#3 pot
Rmy	<i>Rosa meidiland Yellow</i>	Meidiland Rose Yellow	0.3m ht.	#3 pot
Grasses and Perennials				
Ac	<i>Achnatherum calamagrostis</i>	Needle Grass	0.3m ht.	#3 pot
Ep	<i>Echinacea purpurea</i>	Purple Coneflower	0.3m ht.	#3 pot
Fo	<i>Festuca ovina glauca "Elijah Blue"</i>	Blue Fescue "Elijah Blue"		#1 pot
La	<i>Lavandula angustifolia "Nana"</i>	Dwarf Lavender "Nana"	0.3m ht.	#3 pot
Rh	<i>Rudbeckia hirta "Goldstrum"</i>	Black Eyed Susan "Goldstrum"	0.3m ht.	#3 pot

All work to CSLA/CNTA Standards

Plant List Street Zone

Symbol	Latin name	Common Name	Size	Cdn
Trees				
Acr	<i>Acer rubrum 'Franks Red'</i>	Red Maple 'Franks Red'	0.7 cm cal	B&B
Quc	<i>Quercus coccinea</i>	Scarlet Oak	0.7 cm cal	B&B

All work to CNTA/CSLA standards

TREES



Acr *Acer rubrum 'Franks Red'*
Red Maple 'Franks Red'



Quc *Quercus coccinea*
Scarlet Oak

Plant List Green Roofs

SYM	LATIN NAME	COMMON NAME	SIZE	CONDITION
Aa	<i>Allium acuminatum</i>	Hooker's Onion		10 cm. pot
Am	<i>Armeria maritima</i>	Common Thrift		10 cm. pot
El	<i>Eriophyllum lanatum</i>	Woolly Sunflower		10 cm. pot
Fm	<i>Festuca idahoensis</i>	Idaho Fescue		10 cm. pot
Fc	<i>Fragaria chiloensis</i>	Coastal Strawberry		10 cm. pot
Lp	<i>Lonicera pileata</i>	Privet Honeysuckle	0.3m ht.	#1 pot
	<i>Sedum album</i>	Stonecrop		10 cm. pot
	<i>Sedum album 'Murale'</i>	Murale Stonecrop		10 cm. pot
	<i>Sedum reflexum 'Moon Shadow'</i>	Moon Shadow Stonecrop		10 cm. pot
	<i>Sedum rupestre</i>	Rupestre Stonecrop		10 cm. pot
	<i>Sedum spurium 'Dragons Blood'</i>	Two-Row Stonecrop		10 cm. pot



Aa *Allium acuminatum*
Hooker's Onion



Am *Armeria maritima*
Common Thrift

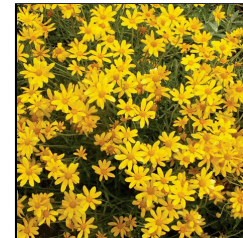

El *Eriophyllum lanatum*
Woolly Sunflower



Fm *Festuca idahoensis*
Idaho Fescue



Fc *Fragaria chiloensis*
Coastal Strawberry



Lp *Lonicera pileata*
Privet Honeysuckle



Sedum album
White stonecrop

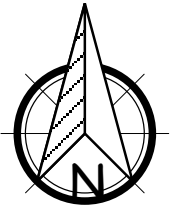

DATE	ISSUED
2019-06-07	Issued for DRC
2021-07-23	Revised and Reissued for Rezoning

REV.	DATE	DESCRIPTION
1.	21/07/23	GENERAL

AMBLESIDE INFILL
ESQUIMALT AVENUE,
WEST VANCOUVER
WALL FINANCIAL CORPORATION

Vaughan
Landscape Planning
and Design
1406 Clyde Ave.,
West Vancouver, B.C.
Canada V7T 1G1
PH:922-1885
FAX:922-5485
office@vaughanplanning.com

DESIGNED	MCV
SCALE	
DATE	July 14, 2016

PLANT LIST GREEN ROOFS AND STREET

DRAWING NO.	REV
L8	1

THIS REVISION SUPERCEDES DRAWINGS BEARING PREVIOUS REVISION NUMBER

Plant List Corner Park

Symbol	Latin name	Common Name	Size	Cdn
Trees				
Acc	<i>Acer circinatum</i>	Vine Maple	3.5m. ht.	B&B
Bep	<i>Betula papifira</i>	Paper Birch	2.0 m. ht.	B&B
Shrubs				
Ec	<i>Erica carnea</i> "Bell's Extra Special"	Winter Flowering Heather "Bell's Extra Special"	0.3m ht.	#3 pot
Sya	<i>Symphocarpus albus</i>	Common Snowberry	0.3m. ht.	#3 pot
Rmw	<i>Rosa meidiland</i> "White"	Meidiland Rose White	0.3m ht.	#3 pot
Vap	<i>Vaccinium parvifolium</i>	Red Huckleberry	1m. ht.	#5 pot
Grasses and Perennials				
Ac	<i>Achnatherum calamagrostis</i>	Needle Grass	0.3m ht.	#3 pot
Bl	<i>Blechnum spicant</i>	Deer Fern		#1 pot
Fi	<i>Festucoa idahoensis</i>	Idaho Fescue		#1 pot
Fc	<i>Fragaria chiloensis</i>	Coastal Strawberry		10 cm pot
Gs	<i>Gaultheria shallon</i>	Salal	10cm pot	0.5m on ctr
Im	<i>Iris missouriensis</i>	Missouri Iris		#1 pot
La	<i>Lavandula angustifolia</i> "Nana"	Dwarf Lavender "Nana"	0.3m ht.	#3 pot
	<i>Polystichum munitum</i>	Western Sword Fern		#1 pot
	<i>Stipa tenuissima</i>	Mexican Feather Grass		#1 pot
All work to CSLA/CNTA Standards				

TREES



Acc *Acer circinatum*
Vine Maple



Bep *Betula papifira*
Paper Birch

SHRUBS

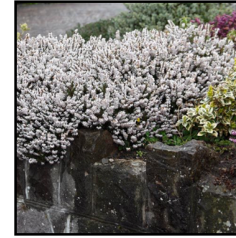

Ec *Erica carnea* 'Springwood White'
Winter flowering heather

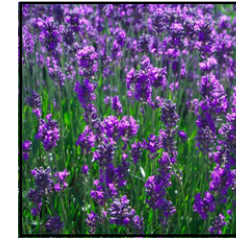

La *Lavandula angustifolia* 'Nana'
Lavender Fern



Rmw *Rosa meidiland* 'White'
Meidiland White Rose



Polystichum munitum
Western Sword Fern



Fc *Fragaria chiloensis*
Coastal Strawberry



Vap *Vaccinium parvifolium*
Decidious huckleberry



Bl *Blechnum spicant*
Deer Fern



Ga *Gaultheria shallon*
Salal



Sya *Symphocarpus albus*
Common Snowberry



Ac *Achnatherum calamagrostis*
Needle Grass



Im *Iris missouriensis*
Missouri Iris



Stipa tenuissima
Mexican Feather Grass

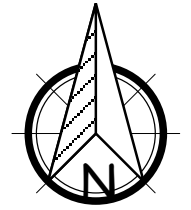

DATE	ISSUED
2019-06-07	Issued for DRC
2021-07-23	Revised and Reissued for Rezoning

TREES

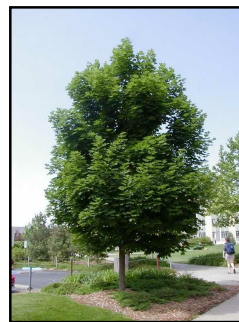

Ap *Acer macrophyllum*
Bigleaf Maple

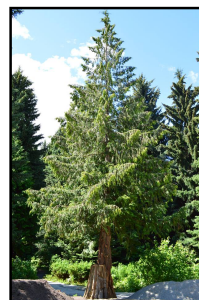

ThP *Thuja plicata*
Western Red Cedar

SHRUBS



Ga *Gaultheria shallon*
Salal



Polystichum munitum
Western Sword Fern



Vap *Vaccinium parvifolium*
Decidious huckleberry



Phl *Philadelphus lewisii*
Mock Orange

Plant List Adjacent Alley

SYM.	LATIN NAME	COMMON NAME	SIZE	CONDITION
TREES				
Acm	<i>Acer macrophyllum</i>	Bigleaf Maple	7 cm. cal.	B&B
Psm	<i>Pseudotsuga menzeisii</i>	Douglas Fir	2.5m. ht.	B&B
Thp	<i>Thuja plicata</i>	Western Red Cedar	2.5m. ht.	B&B
SHRUBS				
Cev	<i>Ceanothus velutinius</i>	Snowbush ceanothus	1.0 m. ht.	#3 Pot
Gs	<i>Gaultheria shallon</i>	Salal		10 cm. pot
Phl	<i>Philadelphus lewisii</i>	Lewis's Mock Orange	1.0 m. ht.	#5 pot
	<i>Polystichum munitum</i>	Western Sword Fern		#1 Pot
Ris	<i>Ribes sanguineum</i>	Red Flowering Currant	1.5 m. ht.	#5 pot
Vap	<i>Vaccinium parvifolium</i>	Red Huckleberry	0.6 m. ht.	#3 Pot

AMBLESIDE INFILL ESQUIMALT AVENUE, WEST VANCOUVER WALL FINANCIAL CORPORATION

Vaughan
Landscape Planning
and Design
1406 Clyde Ave.,
West Vancouver, B.C.
Canada V7T 1G1
PH: 922-1885
FAX: 922-5485
office@vaughanplanning.com

DESIGNED	MCV
SCALE	
DATE	July 14, 2016
TITLE	PLANT LIST ALLEY AND CORNER
DRAWING NO.	L9
REV	1
THIS REVISION SUPERCEDES DRAWINGS BEARING PREVIOUS REVISION NUMBER	

DETAILS FOR CONCRETE PAVERS IN SIDEWALK PARKING ENTRANCE



LEGEND SERIES CONCRETE PAVERS FROM ABBOTSFORD CONCRETE PRODUCTS IN SHADOW COLOUR.

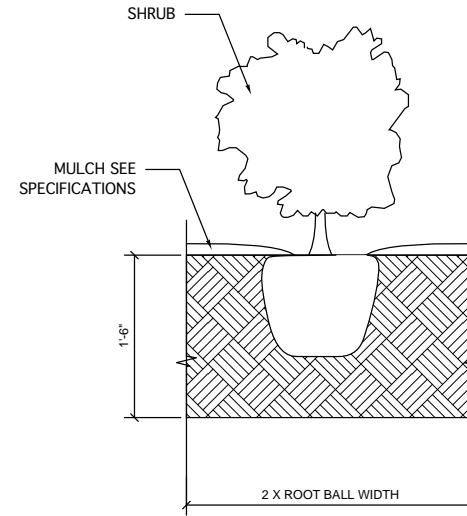

UNLESS OTHERWISE NOTED, SHRUBS TO BE PLANTED IN 18" OF SOIL

SHRUB PLANTING DETAIL

SCALE 1 : 10

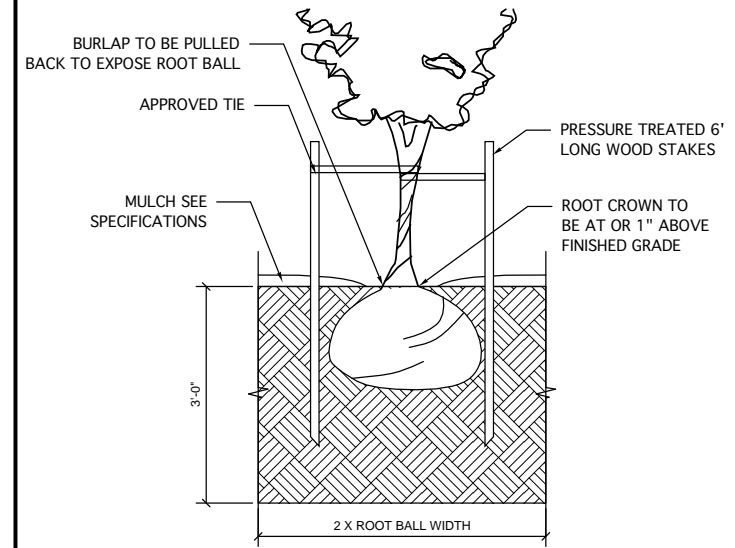

NOTES: ALL PLANT MATERIAL IS TO CSLA/CNTA STANDARDS
DIG THE PLANTING HOLE A MINIMUM OF 2X THE ROOT BALL IN WIDTH
ALWAYS LIFT THE TREE BY THE ROOT BALL, NEVER THE TRUNK
AFTER THE TREE IS SET IN PLACE REMOVE BURLAP, WIRE AND STRAPS FROM AT LEAST THE UPPER 1/3 OF THE ROOT BALL
APPLY 2" OF MULCH - SEE SPECIFICATIONS

UNLESS OTHERWISE NOTED, TREES TO BE PLANTED IN 3' OF SOIL

TREE PLANTING DETAIL

SCALE 1 : 10

TYPICAL PLANTING DETAILS

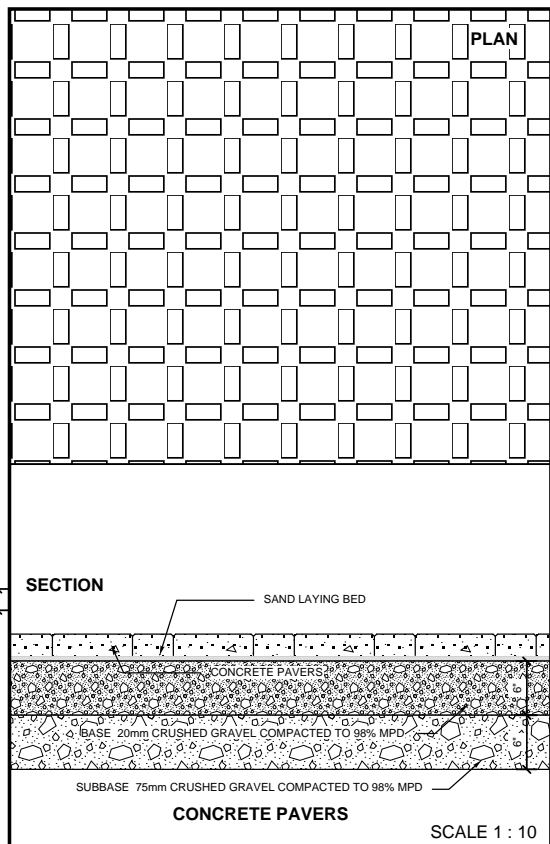

CONCRETE PAVER IN WALKWAY/DRIVEWAY DETAIL

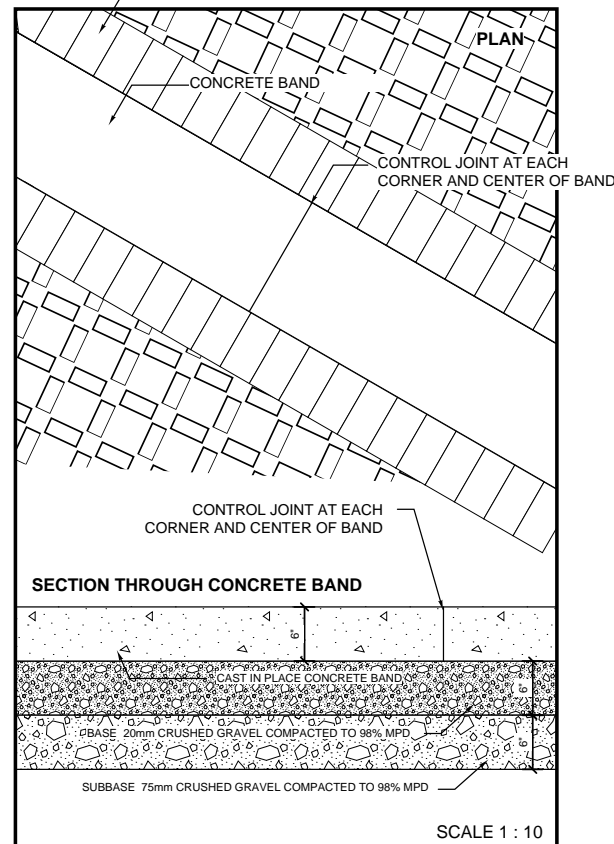

CONCRETE PAVER WITH CONCRETE BAND BETWEEN PAVER BLOCK DETAIL

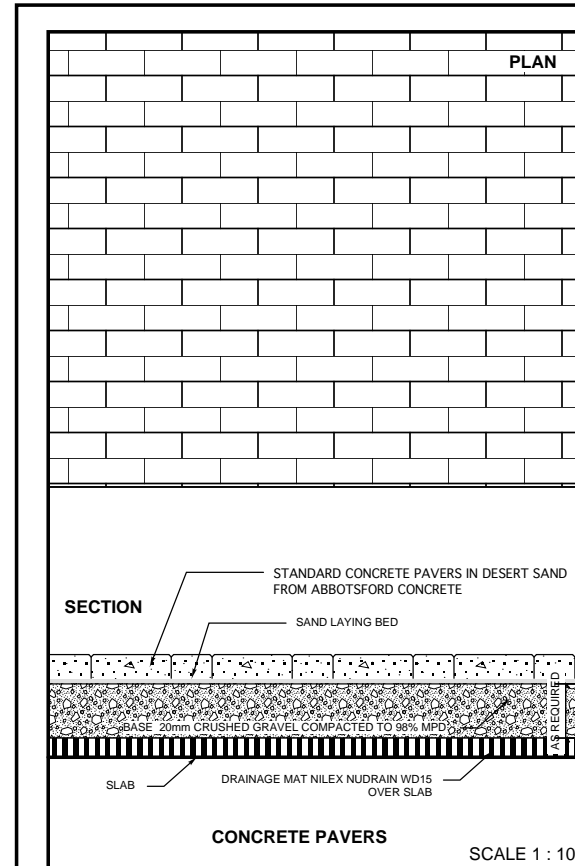

NOTE: DRAINAGE MAT REQUIRED ABOVE ALL SLAB LANDSCAPE
CONCRETE PAVER DETAIL ON SLAB

UNIT PAVER DETAILS

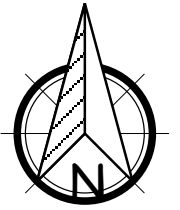
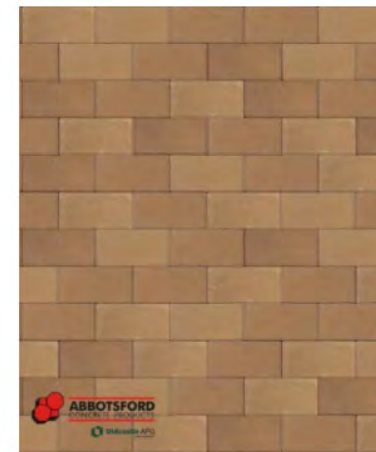

DATE	ISSUED
2019-06-07	Issued for DRC
2021-07-23	Revised and Reissued for Rezoning

REV.	DATE	DESCRIPTION
1.	21/07/23	GENERAL

AMBLESIDE INFILL
ESQUIMALT AVENUE,
WEST VANCOUVER
WALL FINANCIAL CORPORATION

Vaughan
Landscape Planning
and Design
1406 Clyde Ave.,
West Vancouver, B.C.
Canada V7T 1G1
PH:922-1885
FAX:922-5485
office@vaughanplanning.com

DESIGNED	MCV
SCALE	
DATE	July 14, 2016

TITLE **DETAILS PLANTING AND PAVERS**

DRAWING NO.	REV
L10	1

THIS REVISION SUPERCEDES DRAWINGS BEARING PREVIOUS REVISION NUMBER

DETAILS FOR HYDRAPRESSED SLABS

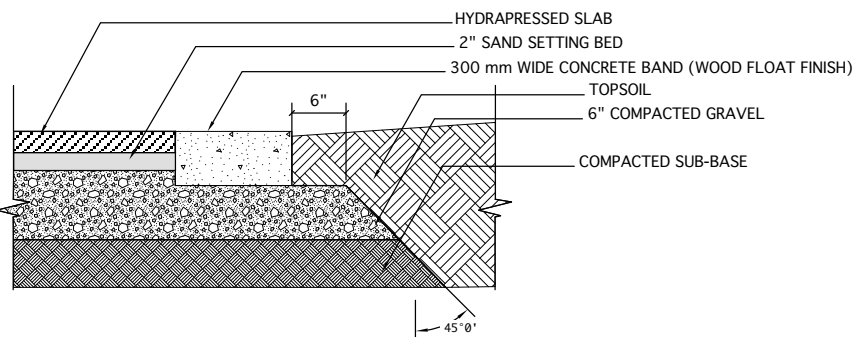
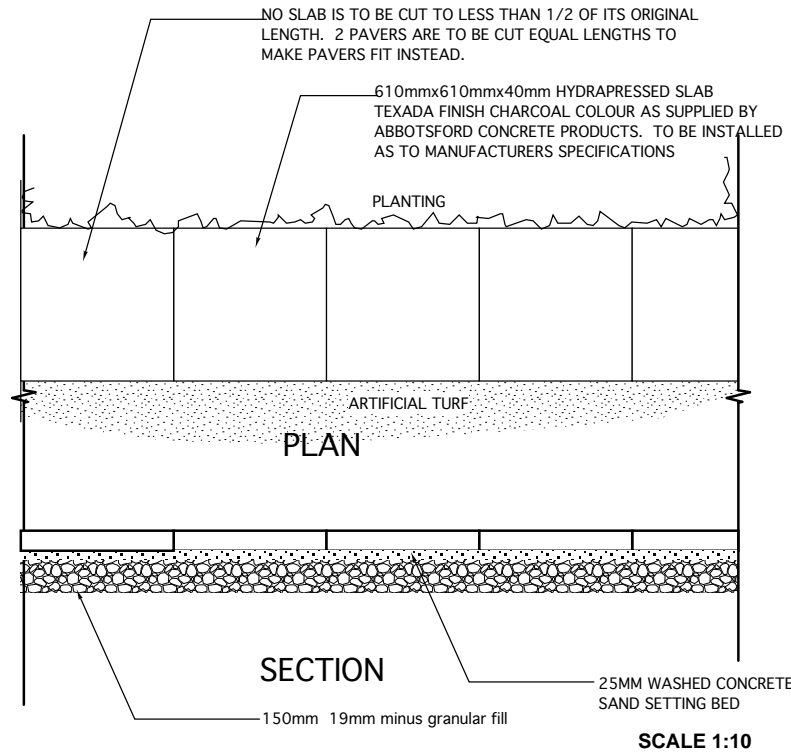

TYPICAL SECTION THROUGH PAVING EDGE

SCALE 1:10

FURNITURE DETAILS

TABLES ON PLAZA



Tables Mameaux 24in Round Top, No Umbrella Hole, Single Embedded Support

www.landscapelforms.com

Date: 7/29/2011
Ph: 800.521.2548

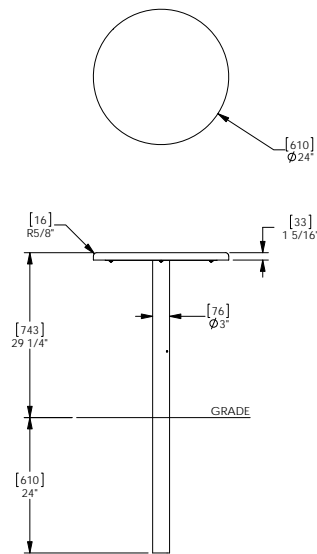

landscapelforms Drawing: MA4003
Dimensions are in inches (mm)

CONFIDENTIAL DRAWING INFORMATION CONTAINED HEREIN IS THE PROPERTY OF LANDSCAPE FORMS, INC. INTENDED USE IS LIMITED TO DESIGN PROFESSIONALS SPECIFYING LANDSCAPE FORMS, INC. PRODUCTS AND THEIR DIRECT CLIENTS. DRAWING IS NOT TO BE COPIED OR DISCLOSED TO OTHERS WITHOUT THE CONSENT OF LANDSCAPE FORMS, INC. © 2013 LANDSCAPE FORMS, INC. ALL RIGHTS RESERVED.



PERGOLA OVER KITCHEN AREA. TO BE GREY GRANITE COUNTER WITH BASALT STONE FACING

Gretchen™ Backed Bench 72in, Freestanding / Surface Mount, Polysite, with Loop Armrest

www.landscapelforms.com Date: 6/29/2011
Ph: 800.521.2548

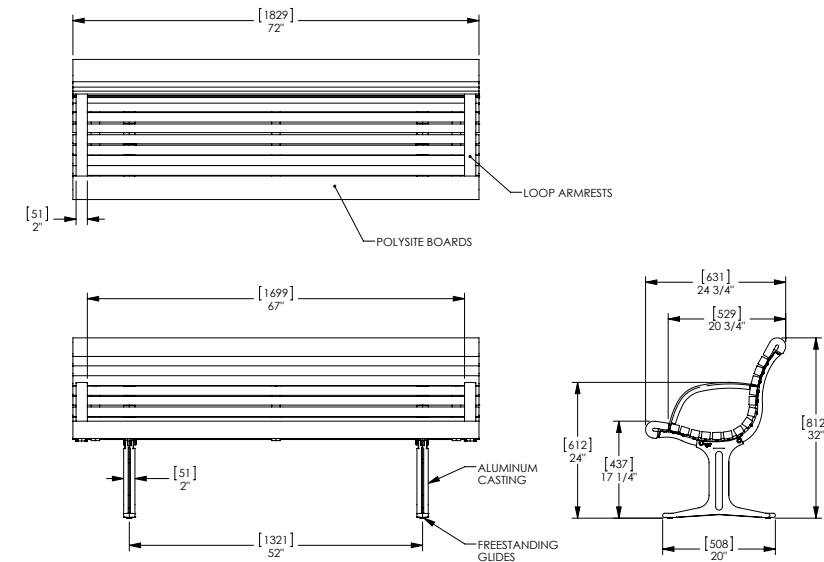

landscapelforms Drawing: GF133-08
Dimensions are in inches (mm)

CONFIDENTIAL DRAWING INFORMATION CONTAINED HEREIN IS THE PROPERTY OF LANDSCAPE FORMS, INC. INTENDED USE IS LIMITED TO DESIGN PROFESSIONALS SPECIFYING LANDSCAPE FORMS, INC. PRODUCTS AND THEIR DIRECT CLIENTS. DRAWING IS NOT TO BE COPIED OR DISCLOSED TO OTHERS WITHOUT THE CONSENT OF LANDSCAPE FORMS, INC. © 2013 LANDSCAPE FORMS, INC. ALL RIGHTS RESERVED.



BENCHES



BUILT IN BARBECUE WITH PREP TABLE

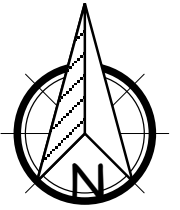

DATE	ISSUED
2019-06-07	Issued for DRC
2021-07-23	Revised and Reissued for Rezoning

REV.	DATE	DESCRIPTION
1.	21/07/23	GENERAL

AMBLESIDE INFILL

ESQUIMALT AVENUE,
WEST VANCOUVER
WALL FINANCIAL CORPORATION

Vaughan
Landscape Planning
and Design

1406 Clyde Ave.,
West Vancouver, B.C.
Canada V7T 1G1
PH: 922-1885
FAX: 922-5485

office@vaughanplanning.com

DESIGNED	MCV
SCALE	
DATE	July 14, 2016

TITLE
**DETAILS
SLABS AND FURNITURE**

DRAWING NO. REV
L11 1

THIS REVISION SUPERCEDES DRAWINGS BEARING PREVIOUS REVISION NUMBER

LITTLE DUCKLING AGES UP TO 2



WIZARDS HIDEAWAY AGES 2 - 5

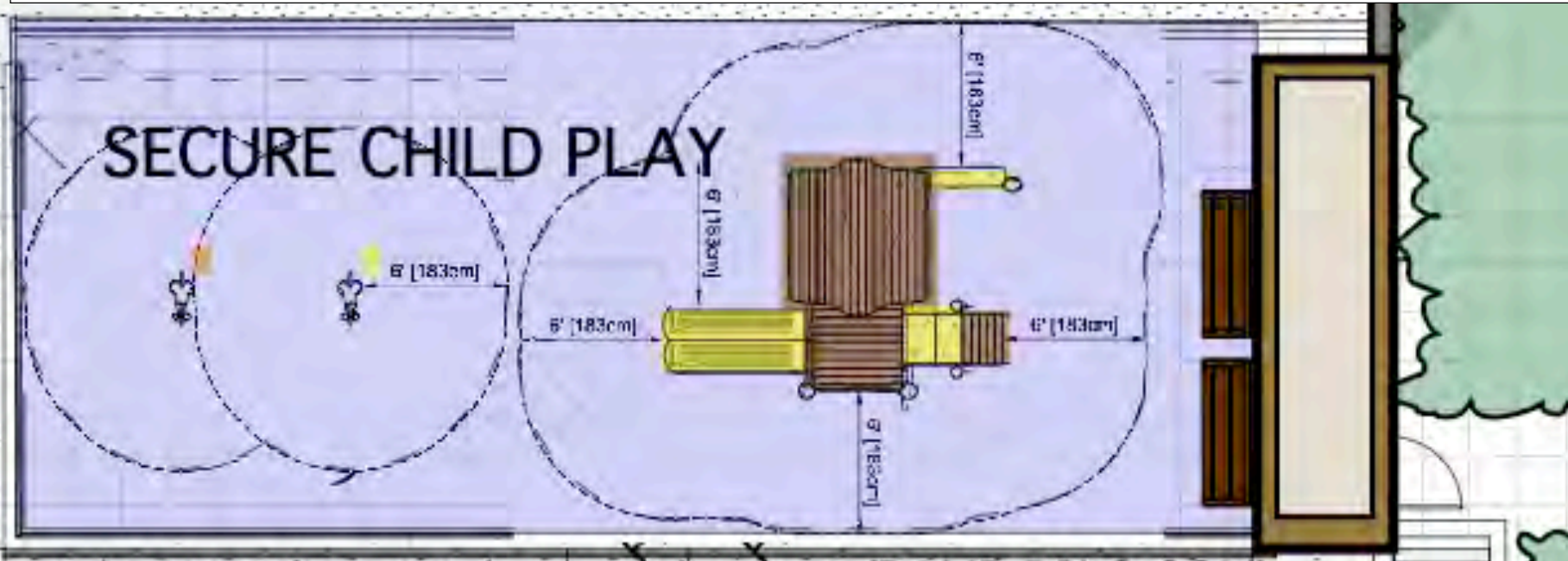

RAMP DN 8.08%

ENLARGED SAFETY ZONE DIMENSIONS

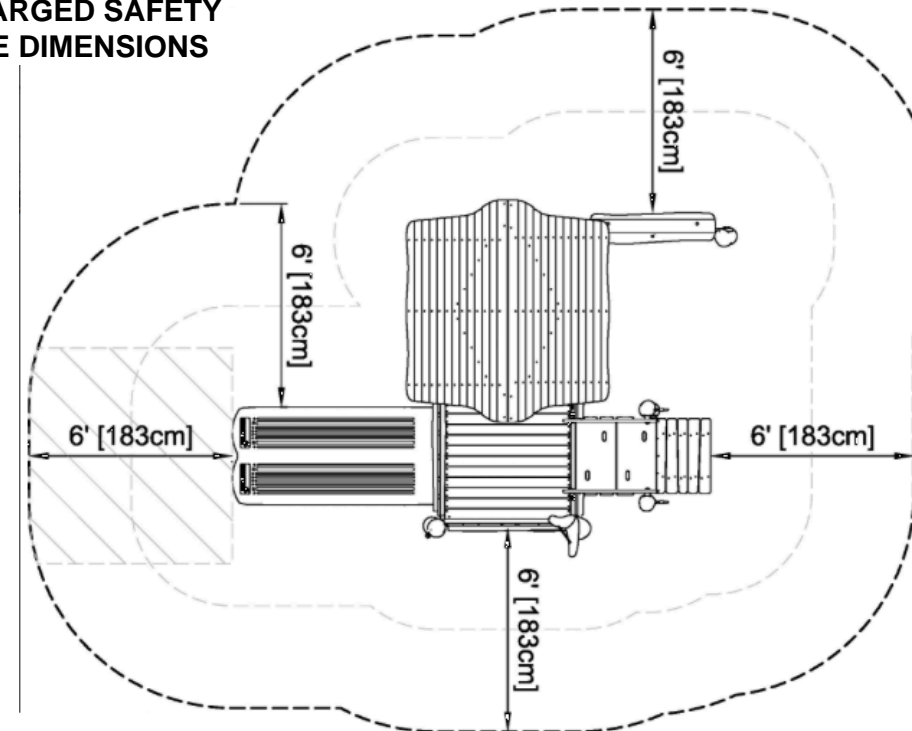

POURED IN PLACE RUBBERIZED SURFACE SHOWN IN BLUE ON PLAN

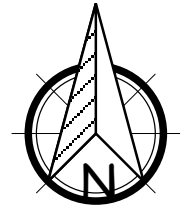

DATE	ISSUED
2019-06-07	Issued for DRC
2021-07-23	Revised and Reissued for Rezoning

REV.	DATE	DESCRIPTION
1.	21/07/23	GENERAL

AMBLESIDE INFILL
ESQUIMALT AVENUE,
WEST VANCOUVER
WALL FINANCIAL CORPORATION

Vaughan
 Landscape Planning
 and Design
 1406 Clyde Ave.,
 West Vancouver, B.C.
 Canada V7T 1G1
 PH: 922-1885
 FAX: 922-5485
 office@vaughanplanning.com

DESIGNED	MCV
SCALE	
DATE	July 14, 2016

TITLE
DETAILS
PLAY AREA

DRAWING NO.	REV
L12	1

THIS REVISION SUPERCEDES DRAWINGS BEARING PREVIOUS REVISION NUMBER